

Каталог ХВОСТОВИКОВ ШИН



oregon.kiev.ua
(044) 332-63-47
(067) 408-84-69

A041

 T041

ПРИМЕНЕНИЕ ДЛЯ ОЕМ-ПРОИЗВОДИТЕЛЕЙ:

Alpina, Bosch, Castor, Cub Cadet®, Dolmar, Echo®, Efco®, Einhell®, Homelite®, Husqvarna®, Ikra, Jonsered®, Makita®, McCulloch®, Oleo-Mac®, Partner, Poulan®/Poulan Pro®, Ryobi®, Shindaiwa, Skil®, Tanaka®, Zenoah, and others

Узел **INTENZ®**

A041

T041

- Узел Carlton® – 10
- Узел Windsor® – PKU

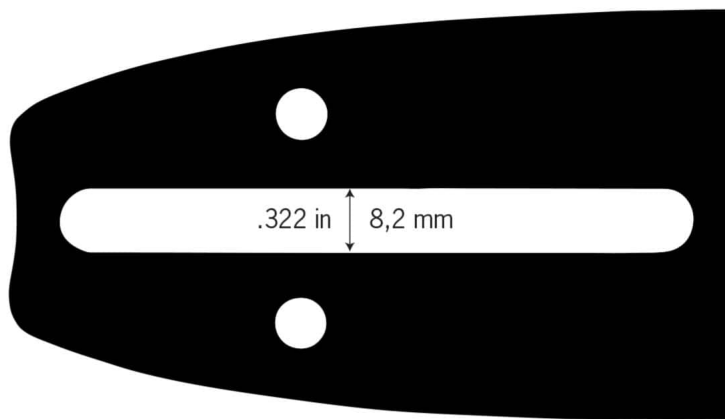

A061

ПРИМЕНЕНИЕ ДЛЯ ОЕМ-ПРОИЗВОДИТЕЛЕЙ:

Homelite®, Sabre

A061

- Узел Carlton® – 28
- Узел Windsor® – MXL

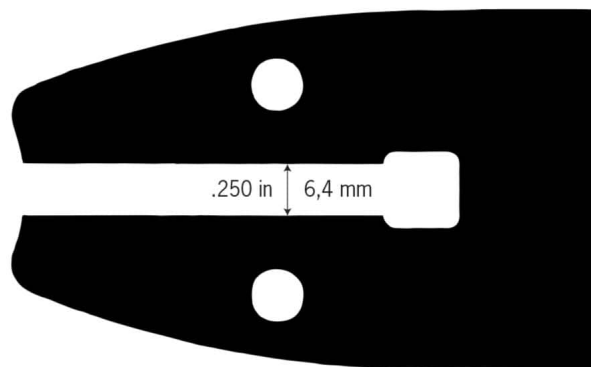

A064

ПРИМЕНЕНИЕ ДЛЯ ОЕМ-ПРОИЗВОДИТЕЛЕЙ:

Einhell®, Husqvarna®, Jonsered®, Skil

A064

- Узел Carlton® – 52
- Узел Windsor® – FJ

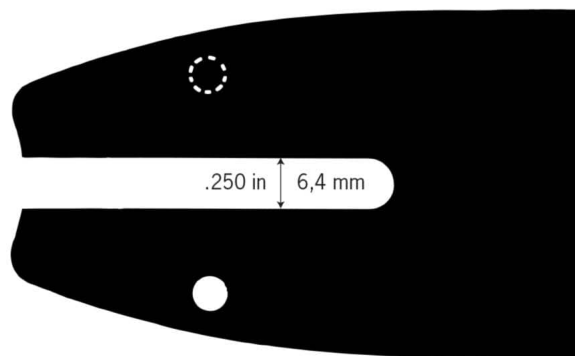

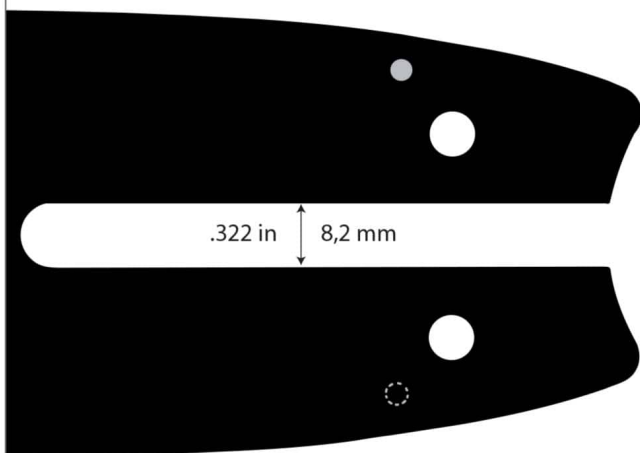
A074**INTENZ® T074****ПРИМЕНЕНИЕ ДЛЯ OEM-ПРОИЗВОДИТЕЛЕЙ:**

Alpina, Castor, Metabo®, Stihl®, Oleo-Mac®

A074**INTENZ®** Узел**T074**

- Узел Carlton® – 26
- Узел Windsor® – ST

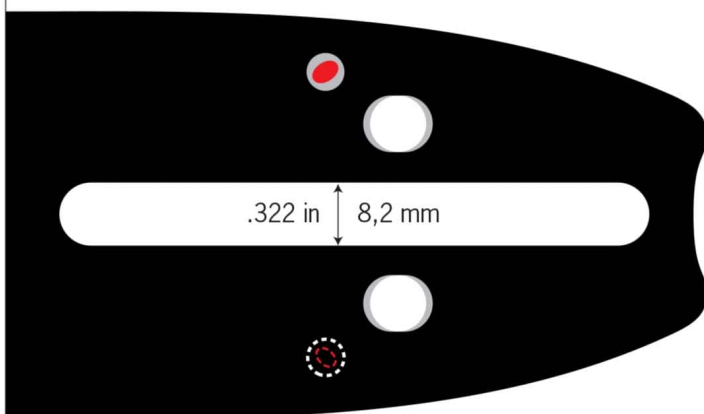
A095**INTENZ® T095****ПРИМЕНЕНИЕ ДЛЯ OEM-ПРОИЗВОДИТЕЛЕЙ:**

Alko, Alpina, Castor, Cub Cadet®, Dolmar, Homelite®, Husqvarna®, Jonsered®, Makita®, McCulloch®, Oleo-Mac®, Partner, Pioneer, Poulan®/Poulan Pro®, Shindaiwa, Solo®, Zenoah®, and others

A095**INTENZ®** Узел**T095**

- Узел Carlton® – 01
- Узел Windsor® – CJL

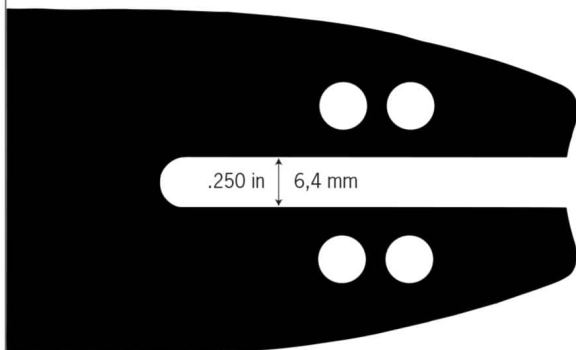
A218**INTENZ® T218****ПРИМЕНЕНИЕ ДЛЯ OEM-ПРОИЗВОДИТЕЛЕЙ:**

Alko, Black & Decker®, McCulloch®, Power Pruner®/Echo® Power Pruner®, Polesaws, Ryobi®, Shindaiwa, Stiga®

A218**INTENZ®** Узел**T218**

- Узел Carlton® – 29

A318

INTENZ® T318

ПРИМЕНЕНИЕ ДЛЯ ОЕМ-ПРОИЗВОДИТЕЛЕЙ:

Alko, Black & Decker®, McCulloch®, Ryobi®, Shindaiwa, Stiga®

INTENZ® Узел

A318
T318

- Узел Carlton® – 38
- Узел Windsor® – MC

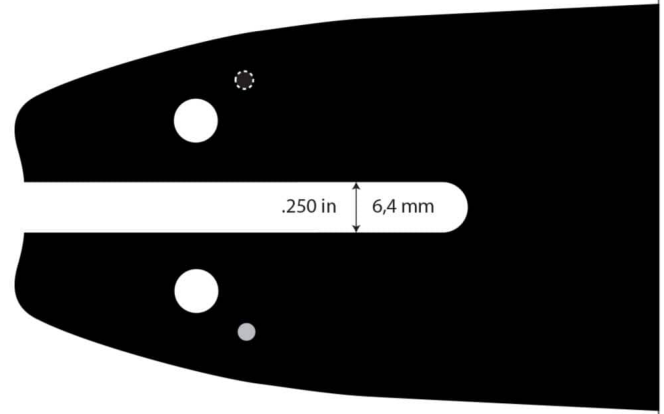

K041

ПРИМЕНЕНИЕ ДЛЯ ОЕМ-ПРОИЗВОДИТЕЛЕЙ:

AEG, Alpina, Dolmar, Homelite®, Husqvarna®, Jonsered®, Makita®, Oleo-Mac®, Partner, Poulan®/Poulan Pro®, Ryobi®, Shindaiwa, Skil, Tanaka®, Zenoah®, and others

K041

- Узел Carlton® – 10W
- Узел Windsor® – PKU

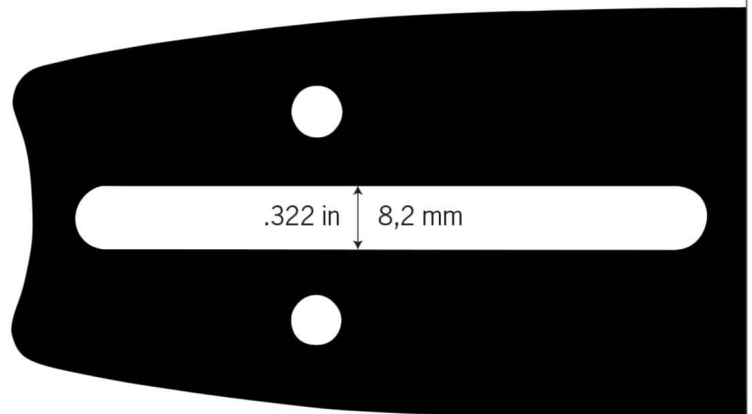

K095

ПРИМЕНЕНИЕ ДЛЯ ОЕМ-ПРОИЗВОДИТЕЛЕЙ:

Alko, Alpina, Castor, Dolmar, Homelite®, Husqvarna®, Jonsered®, Makita®, McCulloch®, Oleo-Mac®, Partner, Shindaiwa, Solo®, Zenoah®, and others

K095

- Узел Carlton® – 01W
- Узел Windsor® – CJL

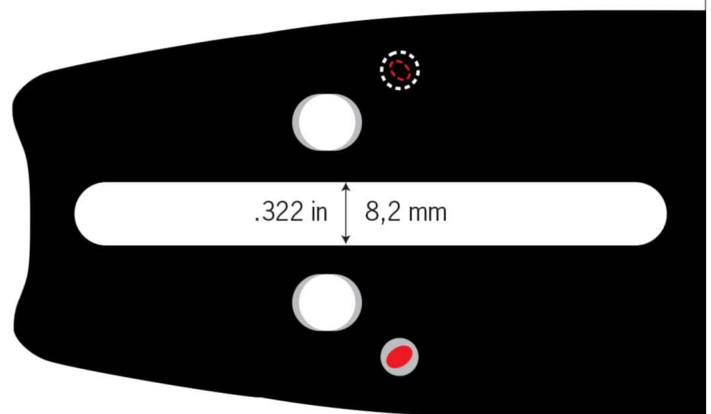

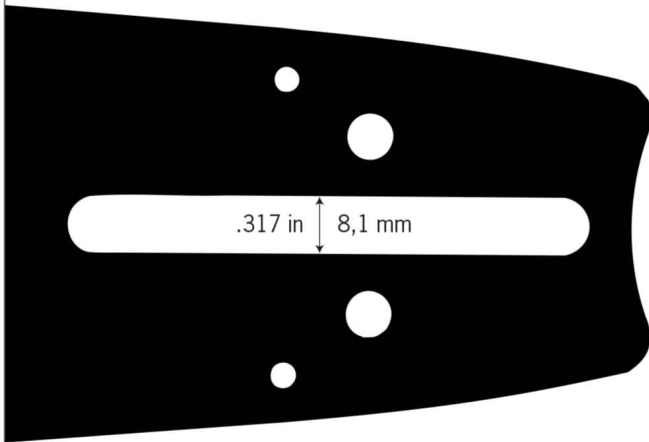
K153**ПРИМЕНЕНИЕ ДЛЯ OEM-ПРОИЗВОДИТЕЛЕЙ:**

Dolmar

K153

- Узел Carlton® – 53

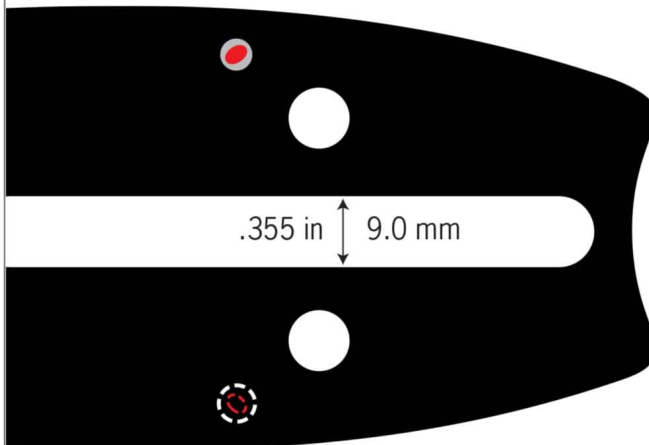
D009**ПРИМЕНЕНИЕ ДЛЯ OEM-ПРОИЗВОДИТЕЛЕЙ:**

Alpina, Castor, Dolmar, Husqvarna®, Jonsered®, Makita®, Partner, Shindaiwa, Solo®

D009

- Узел Carlton® – 81
- Узел Windsor® – EM

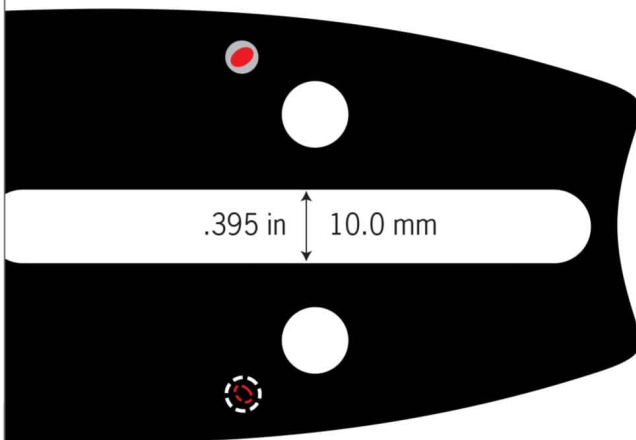
D024**ПРИМЕНЕНИЕ ДЛЯ OEM-ПРОИЗВОДИТЕЛЕЙ:**

Efco®, Jonsered®, Oleo-Mac®

D024

- Узел Carlton® – 71
- Узел Windsor® – JR

D025

ПРИМЕНЕНИЕ ДЛЯ ОЕМ-ПРОИЗВОДИТЕЛЕЙ:

Stihl®

D025

- Узел Carlton® – 42
- Узел Windsor® – 40

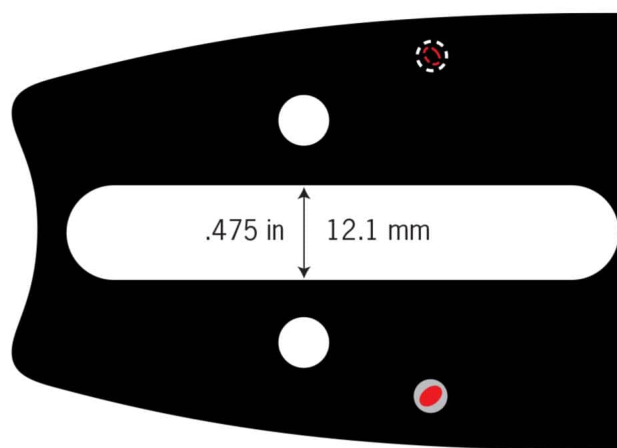

D033

ПРИМЕНЕНИЕ ДЛЯ ОЕМ-ПРОИЗВОДИТЕЛЕЙ:

Dolmar, Makita®, Poulan®

D033

- Узел Carlton® – 42
- Узел Windsor® – 40

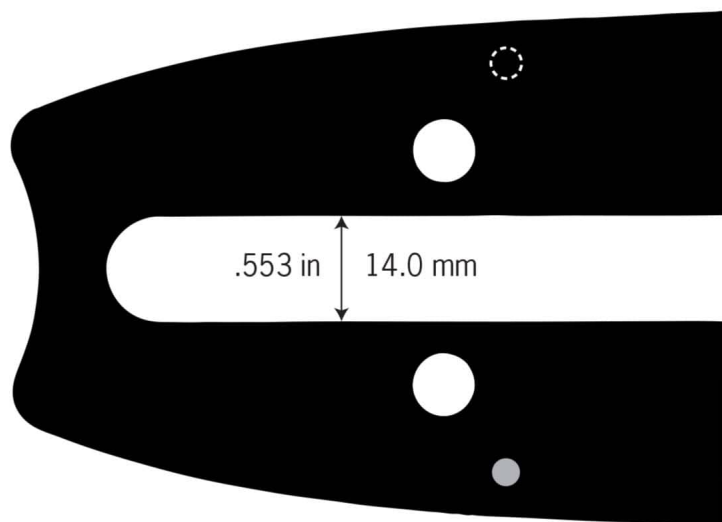

D176

ПРИМЕНЕНИЕ ДЛЯ ОЕМ-ПРОИЗВОДИТЕЛЕЙ:

Alko, Echo®, Poulan®/Poulan Pro®, Tanaka®, Zenoah®

D176

- Узел Carlton® – 41
- Узел Windsor® – UXL

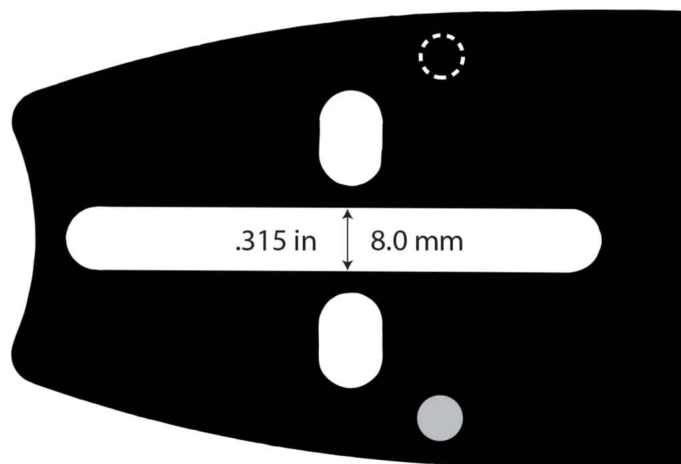

D196

ПРИМЕНЕНИЕ ДЛЯ OEM-ПРОИЗВОДИТЕЛЕЙ:
Echo, Homelite®

D196

- Узел Carlton® – 21
- Узел Windsor® – HL

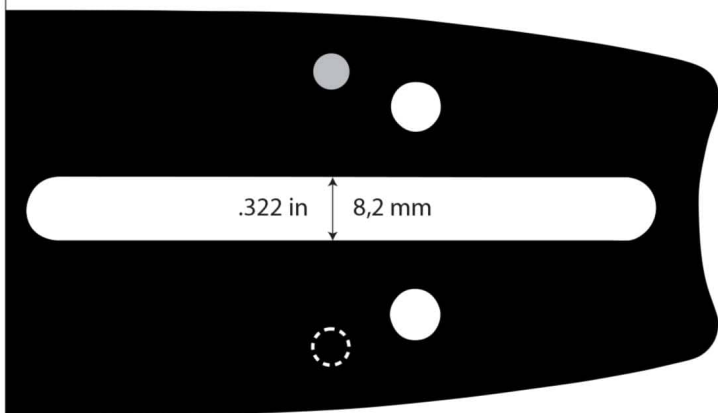

E031

ПРИМЕНЕНИЕ ДЛЯ OEM-ПРОИЗВОДИТЕЛЕЙ:
Hydrochief, Oleo-Mac®, Stihl®

E031

- Узел Carlton® – 55
- Узел Windsor® – 07

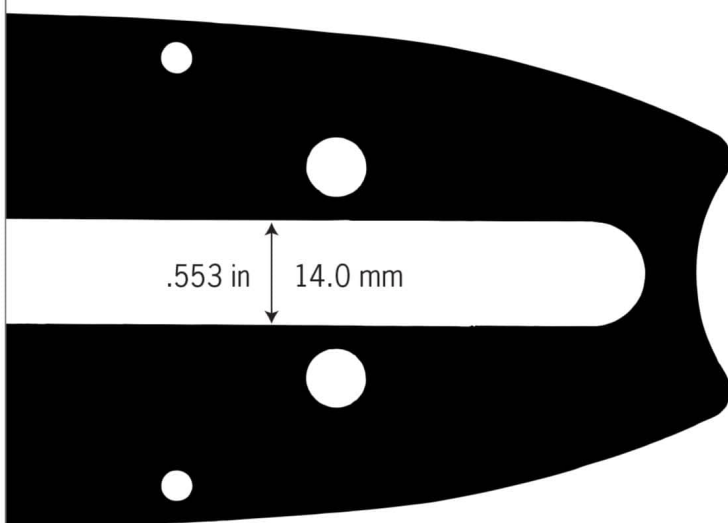

E099

ПРИМЕНЕНИЕ ДЛЯ OEM-ПРОИЗВОДИТЕЛЕЙ:
Echo®, Hydrochief, Stihl®

E099

- Узел Carlton® – 57 & 07
- Узел Windsor® – WZ

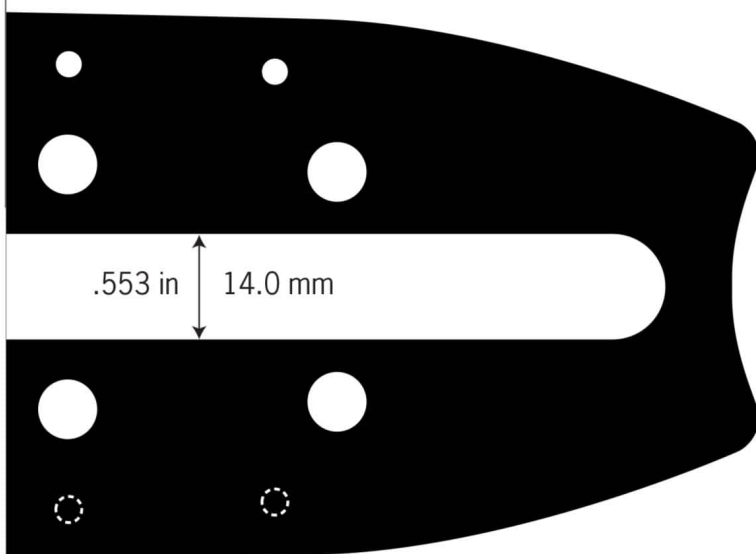

B083

ПРИМЕНЕНИЕ ДЛЯ OEM-ПРОИЗВОДИТЕЛЕЙ:

Dolmar, Makita®

B083

